

# Data Sheet

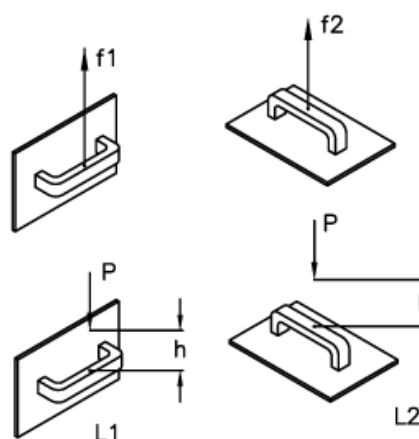

Article number: 2304037136  
Description: E+G Handle  
M.443/140-SH

## Measures

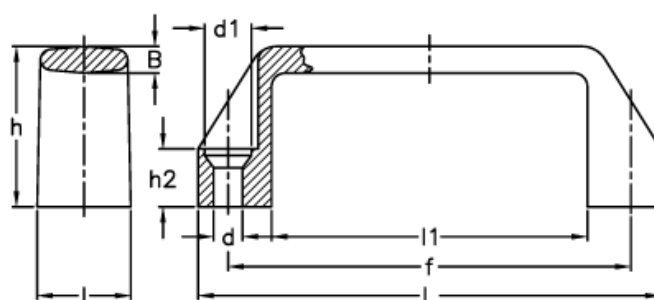

$$L[J]=P[N]\cdot h[m]$$

B	= 7	l	= 26
d	= 6.5	L	= 134
d1	= 12	l1	= 95
f	= 117 +/- 1	L1 (J)	= 17
F1 (N)	= 2500	L2 (J)	= 7
F2 (N)	= 2300		
h	= 41		
h2	= 15		